

**SECRET
SECRET**

[REDACTED]

COPY NO. _____
25 PAGES
(Including Cover Sheet)



CORONA "L" FLIGHT DATA BOOK

SYSTEM NO. L-2

VEHICLE NO. 1165

MISSION NO. 8002

PREPARED BY: _____

CHECKED BY: _____

APPROVED BY: [REDACTED] MANAGER
REQUIREMENTS AND ANALYSIS

APPROVED BY: [REDACTED] _____
PROGRAM MANAGER

APPROVED BY: _____
(S.E.T.D.)

Declassified and Released by the N R O

In Accordance with E. O. 12958

on NOV 26 1997

**SECRET
SECRET**

[REDACTED]

~~SECRET~~
L-2
SYSTEM NO _____
VEHICLE NO 1165
MISSION NO 8002
PANORAMIC INSTRUMENT NO 5

TABLE OF CONTENTS

	PAGE NO.
Vehicle Layout	<u>2</u>
General Flight Data and Pre-Launch Settings	<u>3</u>
Cycle Periods, IAC and Scan Data	<u>4</u>
Panoramic Instrument Lens Data Summary	<u>5</u>
Stellar/Index Lens Data Summary	<u>6</u>
Angular Relations	<u>7</u>
Preliminary Clock Correlation	<u>8</u>
Binary Data Block Layout	<u>9</u>
Performance Estimate	<u>NONE</u>
Description On Angular Relations	<u>10-12</u>
V/h Ramp Plots	<u>13-22</u>
Scan Rate Plot	<u>23</u>
Cycle Rate Plot	<u>24</u>

SYSTEM NO. L-2
 VEHICLE NO. 1165
 MISSION NO. 8002
 PANORAMIC INSTRUMENT NO. 5

SECRET

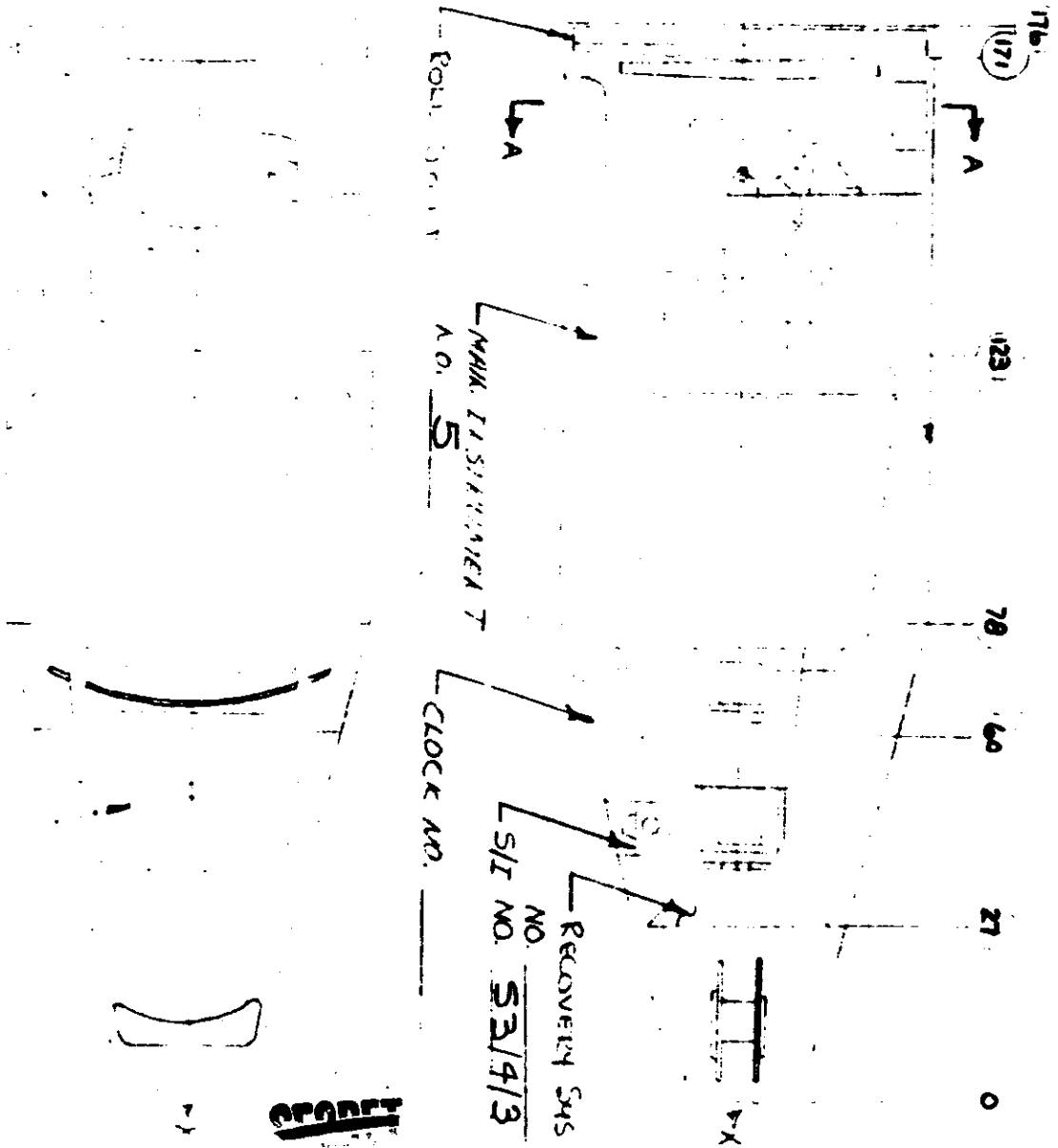
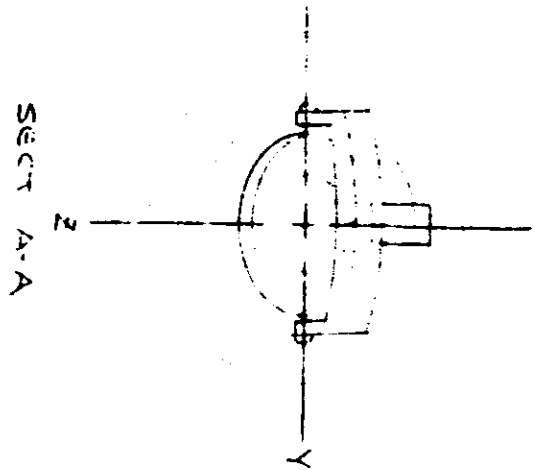

Approved: _____

SECRET

SYSTEM NO L-2
VEHICLE NO 1165
MISSION NO 8002
PANORAMIC INSTRUMENT NO 5

~~SECRET~~
~~SECRET~~

GENERAL FLIGHT DATA AND PRE-LAUNCH SETTINGS:



Panoramic Instrument Serial No. 5
Stellar/Index Serial Number 53/4/3
Launch Date 5-18-63

Command Settings at Launch:

Command	8	9	10	11	12	15
Setting	9	1	6	3	11	11

Panoramic Instrument Settings:
Slit Width 0.246 Inch
Filter Type WRATTEN 12

Stellar/Index Settings:

	Stellar	Index
Exposure Time	<u>2.0</u> sec.	<u>1/500</u> sec.
Aperture Setting	<u>F1.9</u>	<u>F4.5</u>
Filter Type	<u>NONE</u>	<u>WRATTEN 21</u>

Ratio: One Stellar/Index Frame Per 10 Panoramic Frames

Film:

	Panoramic	Stellar	Index
Type	<u>5J31(SO132)</u>	<u>35x75(SPEC)</u>	<u>7J-33-135</u>
Length	<u>8000</u>	<u>75</u>	<u>135</u>
No. of Splices	<u>3</u>	<u>1</u>	<u>NONE</u>
Emulsion Data	<u>29-2-3-3</u>	<u>4401/4400</u>	<u>1-6-2-3</u>

Orbital Parameters: (Orbit 12 Data)

Period 91.13 Min. Eccentricity .0266
Perigee 86.3 N.M. Perigee Latitude 39.3 deg.
Apogee 279 N.M. Inclination Angle 74.63 deg.
Recovery Orbit 33. Recovery Date 5-21-63.

~~SECRET~~
~~SECRET~~



SYSTEM NO L-2
 VEHICLE NO 1165
 MISSION NO 8002
 PANORAMIC INSTRUMENT NO 5

~~SECRET~~

CYCLE PERIODS, IMC AND SCAN DATA

Scan Velocity:

$\frac{95.79}{\text{Cycle Period}}$ (inches/second)

$\frac{83.153}{\text{Cycle Period}}$ (degrees/second)

$\frac{1.451}{\text{Cycle Period}}$ (Radians/second)

IMC Velocity:

$\frac{4.127}{\text{Cycle Period}}$ (Inches/second)

$\frac{0.0625}{\text{Cycle Period}}$ (Radians/seconds)

Pre-Flight Cycle Period		
V/H Ramp	Time Up Ramp	Cycle Period
1	SEE V/H PLOTS PAGE 13-22	
2		
3		
4		
5		
6		
7		
8		
9		
10		

In-Flight Cycle Period		
V/H Ramp	Time Up Ramp	Cycle Period
	NOTE	
	AVAILABLE	

~~SECRET~~

SYSTEM NO. L-2
VEHICLE NO. 1165
MISSION NO. 8002
PANORAMIC INSTRUMENT NO. 5

~~SECRET~~
~~SECRET~~



PANORAMIC INSTRUMENT LENS DATA SUMMARY

Lens Serial Number 09
Flight Slit Width 0.246 Inch
Flight Filter Type WRATTEN 12
Effective Operational Focal Length 65.911 inches

Dynamic Resolution: (Figure of Merit)

	Lines/MM	Film Type	Target	Slit
Itak Pre-Vibration	<u>81.5</u>	<u>S0132</u>	<u>LOW</u>	<u>.133</u>
Itak Post-Vibration	<u>75.0</u>	<u>S0132</u>	<u>LOW</u>	<u>.133</u>
AP (THRU FOCUS)	<u>67.0</u>	<u>S0132</u>	<u>LOW</u>	<u>.246</u>
AP (POST SHAKE)	<u>48.0</u>	<u>S0132</u>	<u>LOW</u>	<u>.265</u>

Distortion:

Angle off Axis Deg.	-2.0	-1.5	-1.0	-0.5	0	+0.5	+1.0	+1.5	+2.0
Distortion Millimeters	.003	.003	.003	0	0	0	0	0	0

~~SECRET~~
~~SECRET~~



SIDELINE NO. 4-2
 VEHICLE NO. 1165
 MISSION NO. 8002
 PANORAMIC INSTRUMENT NO. 5

~~SECRET~~

STELLAR/INDEX LENS DATA SUMMARY:

	Stellar	Index
Lens Serial No.	<u>80039</u>	<u>809932</u>
Reseau Serial No.	<u>3</u>	<u>4</u>
Flight Filter Type	<u>NONE</u>	<u>WRITTEN 21</u>
Flight Aperture	<u>F1.9</u>	<u>F4.5</u>
Flight Exposure Time	<u>2.0</u> Sec.	<u>1/500</u> Sec.
Equivalent Focal Length	<u>83.76</u> MM	<u>38.30</u> MM
Operational Focal Length	<u>83.76</u> MM	<u>38.37</u> MM

Resolution:

Angle Off Axis
Resolution L/MM High Contrast
Resolution L/MM Low Contrast

NOT AVAILABLE

0	10	20	30	35
113/113	118/115	112/101	64/59	58/33
71/64	77/75	78/66	54/36	48/32

 L/MM AWAR from film

72.8 L/MM AWAR from 50130 film

Distortion:

Angle Off Axis Deg.	0	2.5	5.0	7.5
Distortion Millimeters	.000	.000	.000	.004

0	10	20	30	35
.000	.013	.058	.137	.191

Perpendicularity of Reseau to Optical Axis .000 (IN 35 MM)

.060 (IN 57.15 MM)

Location of Principal Point:

X -0.055 MM +0.026 MM
 Y +0.065 MM -0.061 MM

Knee Calibration: NOT AVAIL. Deg. Min. Sec.

Date of Stellar Calibration: NOT AVAILABLE

~~SECRET~~

SYSTEM NO. L-2
VEHICLE NO. 1165
MISSION NO. 8002
PANORAMIC INSTRUMENT NO. 5

~~SECRET~~
~~SECRET~~



ANGULAR RELATIONS:

Optical Axis of Index to optical axis of Panoramic Instrument:

Perpendicularity 90° ± 5.25'
Rotational ± 24.4'

Mirror Positions with respect to yaw axis:

Forward Position 52° 16' 35"
Normal Position 49° 41' 06"
Aft Position 37° 08' 17"

Roll Steering Angles

Nominal	Calibrated
<u>+30</u>	_____
<u>+15</u>	_____
<u>0</u>	_____
<u>-15</u>	_____
<u>-30</u>	_____

} NOT AVAILABLE
(ACCEPT. LIMITS = Nom. ± 1/4°)

Angular relation between Stellar and Index:

NOT AVAILABLE

~~SECRET~~
~~SECRET~~



SYSTEM NO. 1-2
VEHICLE NO. 1165
MISSION NO. 8002
PANORAMIC INSTRUMENT NO. 5

~~SECRET~~
~~SECRET~~



PRELIMINARY CLOCK CORRELATION:

REV. NO.	SYSTEM TIME	CLOCK TIME	DELTA SYSTEM TIME	DELTA CLOCK TIME	DIFF
_____	<u>NONE AVAILABLE</u>			_____	_____
_____	_____	_____	_____	_____	_____
_____	_____	_____	_____	_____	_____
_____	_____	_____	_____	_____	_____
_____	_____	_____	_____	_____	_____
_____	_____	_____	_____	_____	_____
_____	_____	_____	_____	_____	_____
_____	_____	_____	_____	_____	_____
_____	_____	_____	_____	_____	_____
_____	_____	_____	_____	_____	_____

~~SECRET~~
~~SECRET~~



SYSTEM NO. L-2
 VEHICLE NO. 1165
 MISSION NO. 8008
 PANORAMIC INSTRUMENT NO. 5

~~SECRET~~

DATA BLOCK LAYOUT:

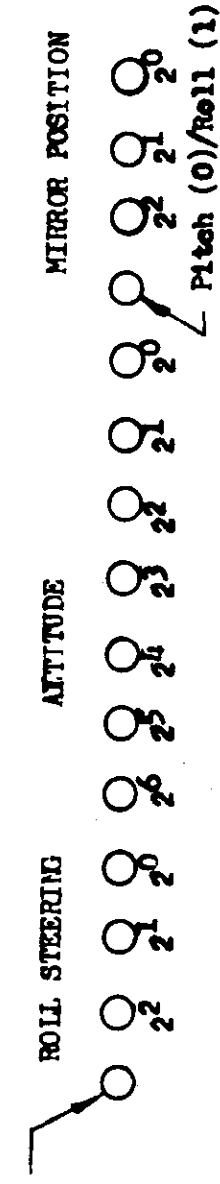
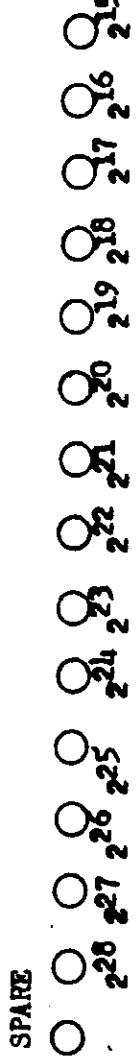
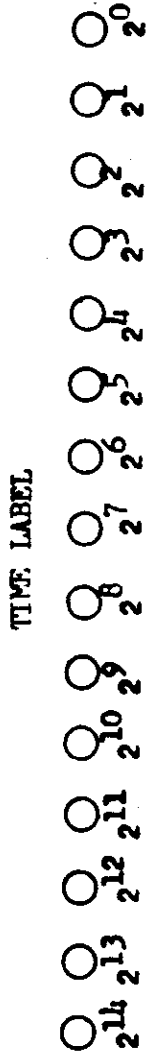
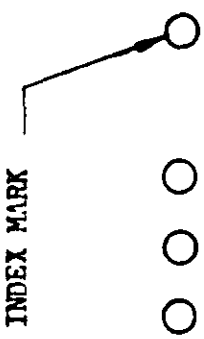

		ATTITUDE						
		26	25	24	23	22	21	20
	-5	0	0	0	0	0	0	0
	0	1	0	0	0	0	0	0
	4.9	1	1	1	1	1	1	1

		ROLL STEERING		
		22	21	20
+30°	1	0	1	1
+15°	0	1	0	0
0°	0	0	1	0
-15°	0	1	0	0
-30°	1	0	1	0

		MIRROR POSITION		
		22	21	20
Forward	1	0	0	0
Vertical	0	1	0	0
Aft	0	0	0	1

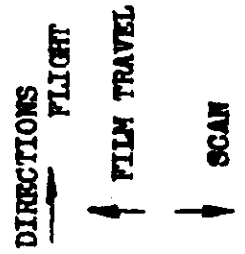

~~SECRET~~

SYSTEM NO

L-2

~~SECRET~~

PAGE 10 OF 24

VEHICLE NO

1165

MISSION NO

8002

PANORAMIC INSTRUMENT NO

5

DESCRIPTION OF ANGULAR RELATIONS

Reflector Alignment

Reflector alignment is performed by positioning the camera subsystem in a test fixture with the plane defined by the pitch and roll axes vertical. With the reflector removed, a theodolite is sighted through the lens cell and centered on the platen center. The reflector is then installed in the normal position and a second theodolite is positioned so the reflector can be viewed normally in all three positions. This theodolite is focused on the platen center through the lens cell by viewing through the reflector. The alignment errors and repeatability are then obtained by measuring the angular relationship of the two theodolites related to the camera subsystem after cycling the reflector. Tests are run on the forward, rear, and normal positions of the reflector.

Optical Axis of Index to Optical Axis of Panoramic Instrument

The optical axis of the Index camera to the Panoramic Instrument has not been calibrated. The tolerances given are mechanical tolerances. Diagrams showing the possible mechanical variations in the location of the instrument mounting surfaces are included.

~~SECRET~~

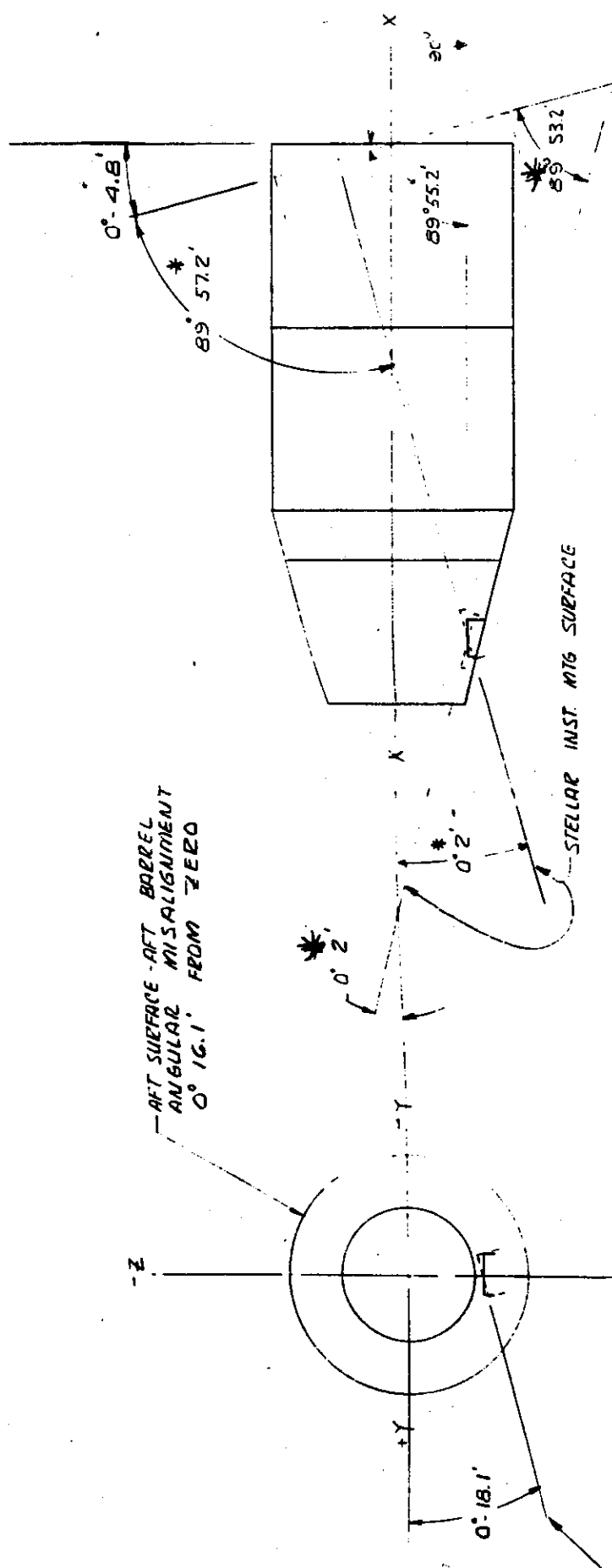

SECRET

3-13-63

SECRET

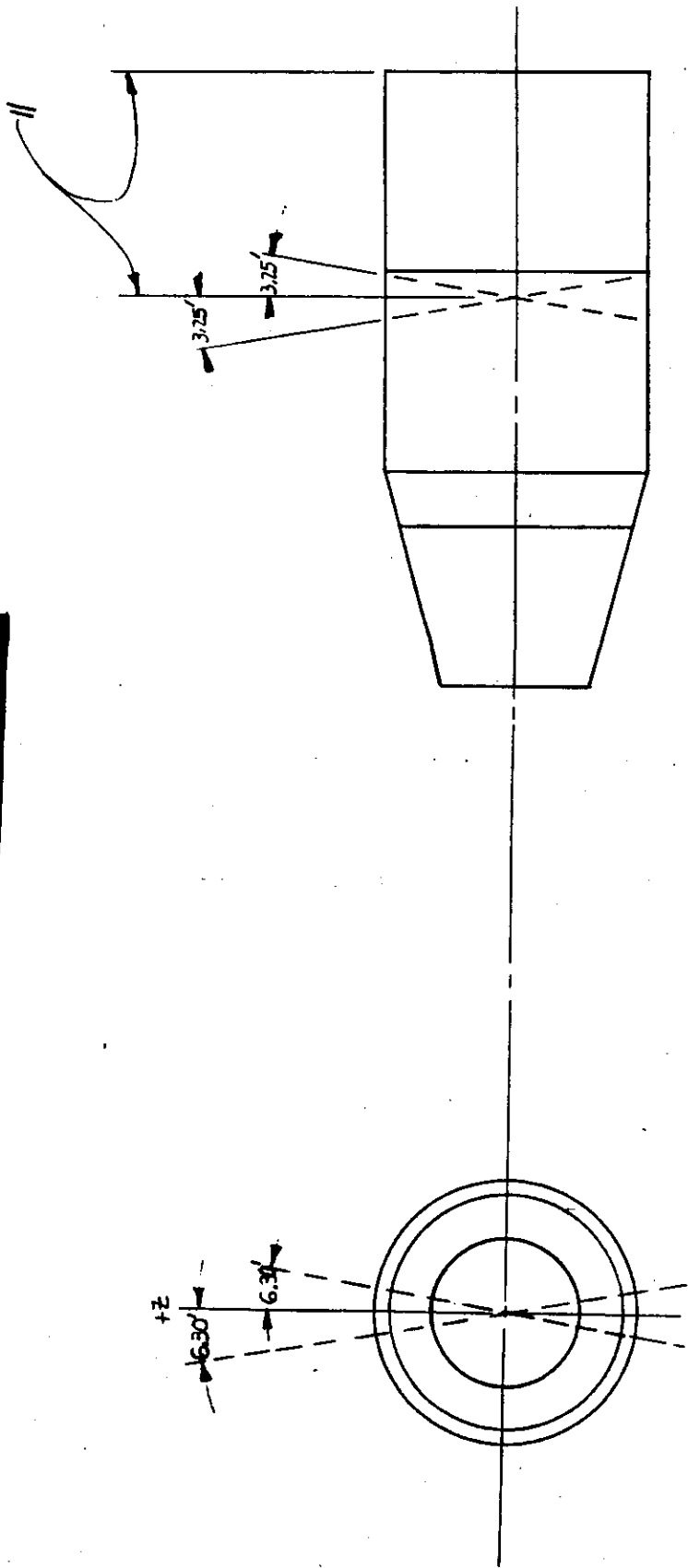

MAIN INSTRUMENT

3-14-63

SECRET

PREPARED BY: [redacted]
DATE: [redacted]
CHECKED BY: [redacted]

SECRET

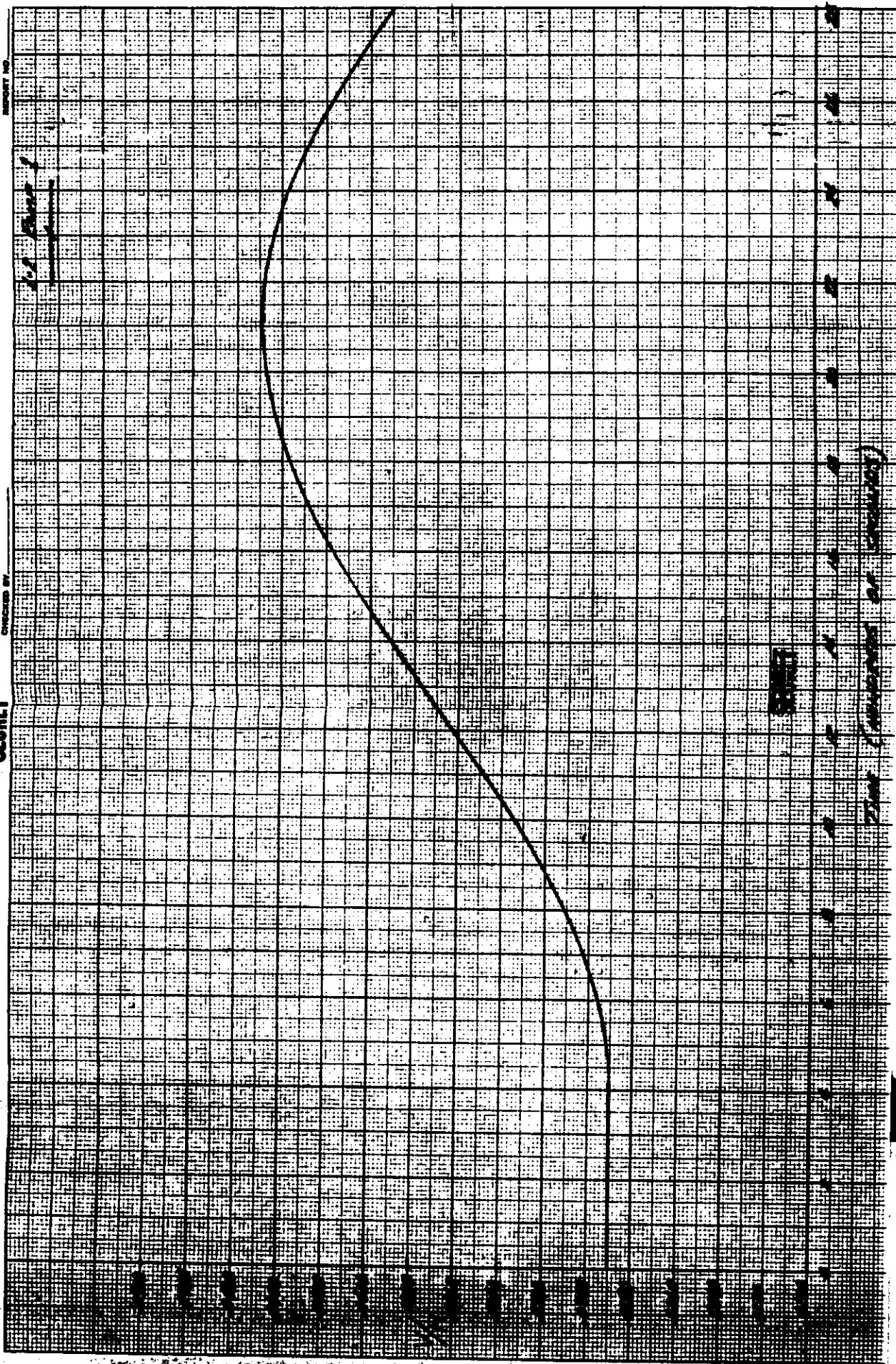

Time (minutes or seconds)

[redacted]

PREPARED BY
DATE
CHECKED BY

OFFICE
VELOCITY

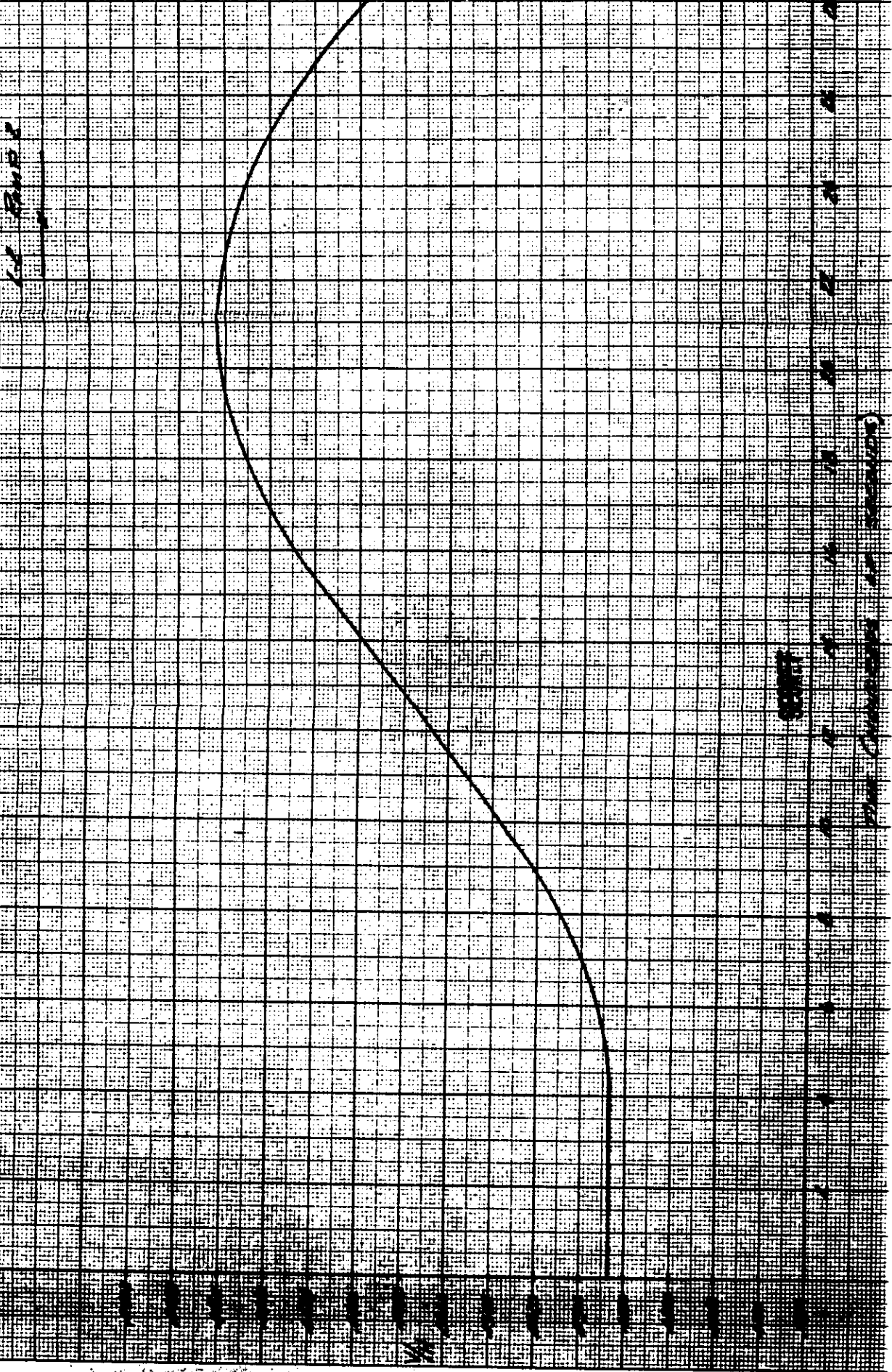

PREPARED BY
DATE
CHECKED BY

REVISED
DATE

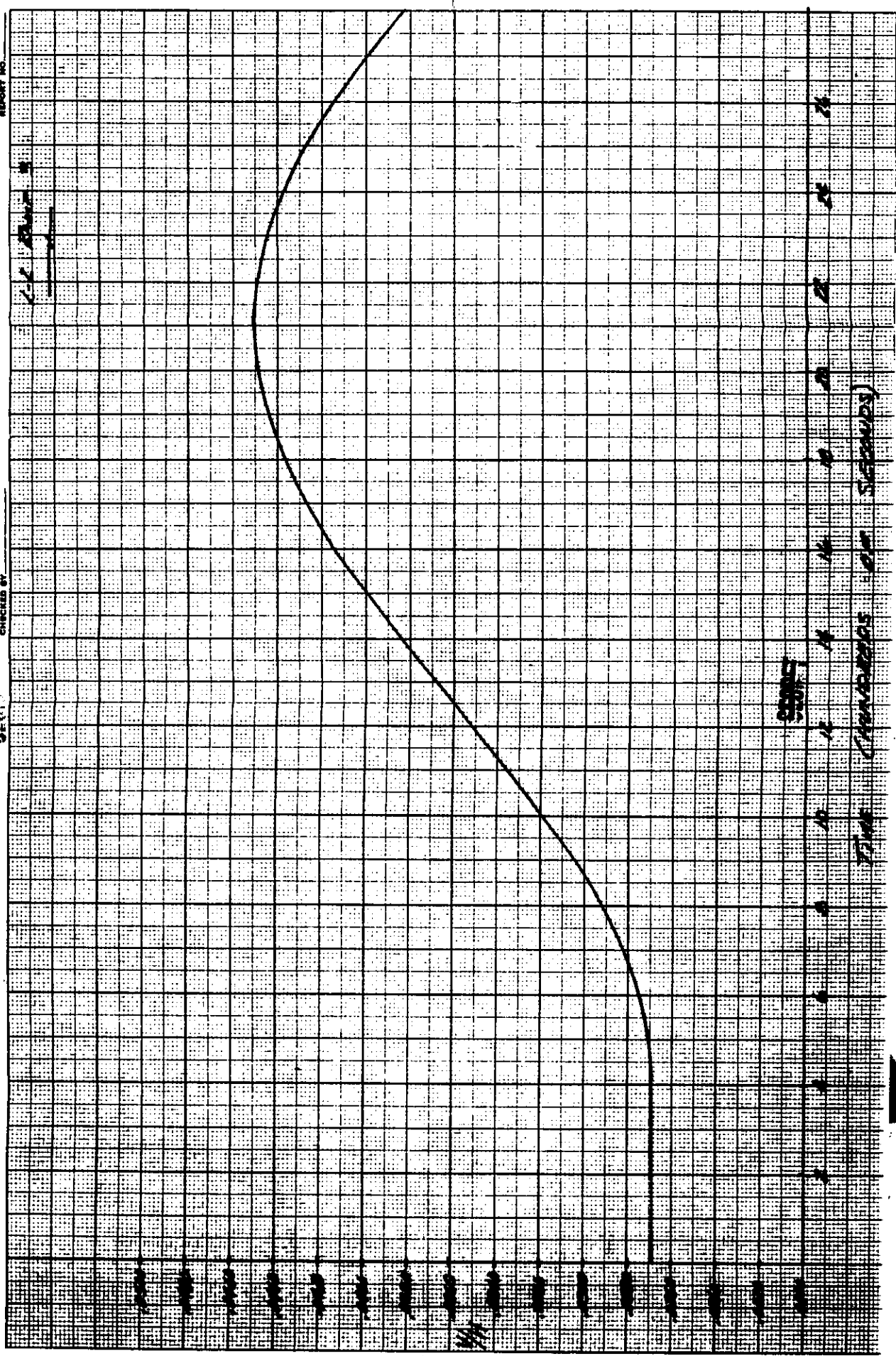

SCALE

TIME (HOURS OF SECOND)

PREPARED BY
DATE
CHECKED BY

SECRET

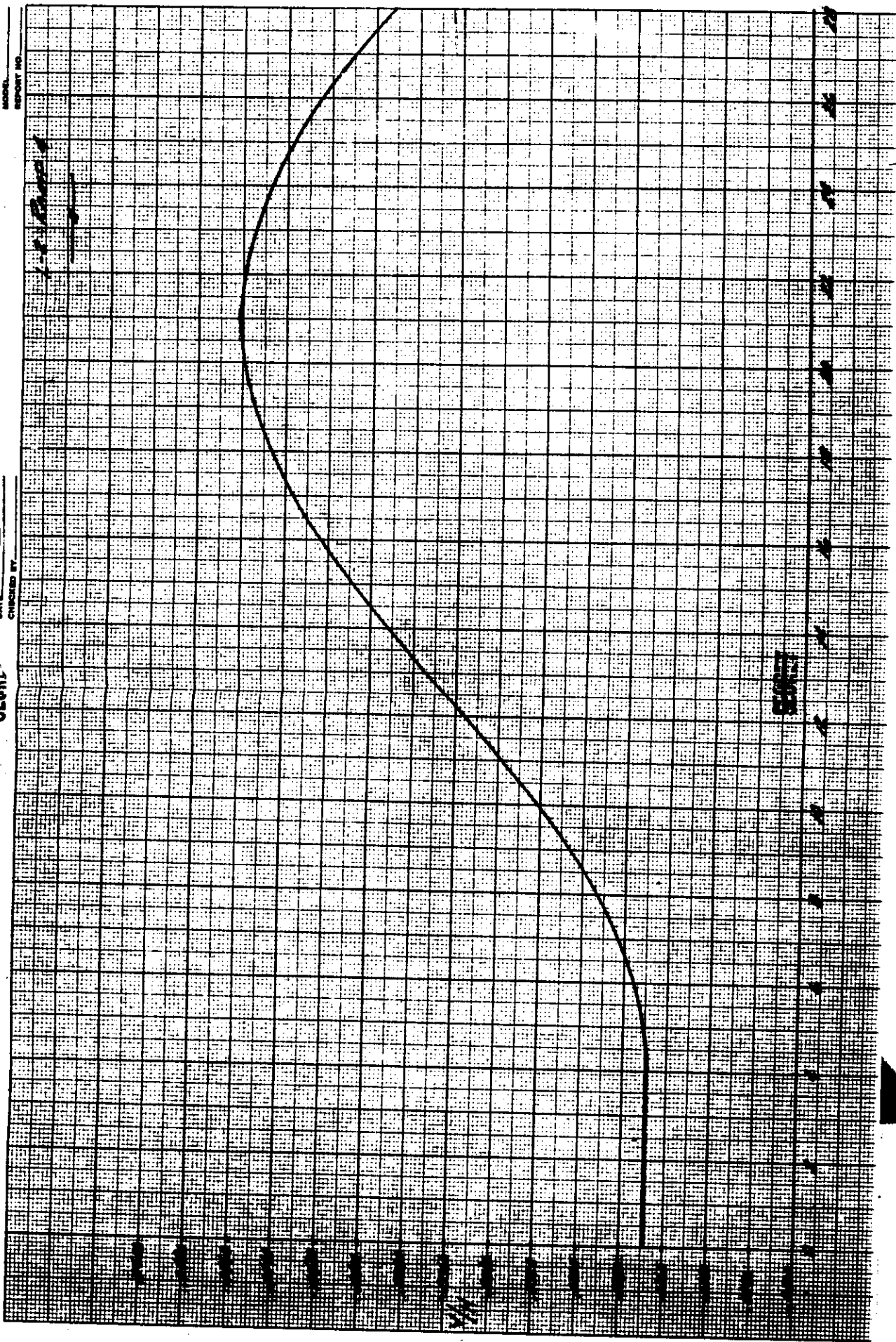

PREPARED BY
DATE
CHECKED BY

SECURITY
CLASSIFICATION

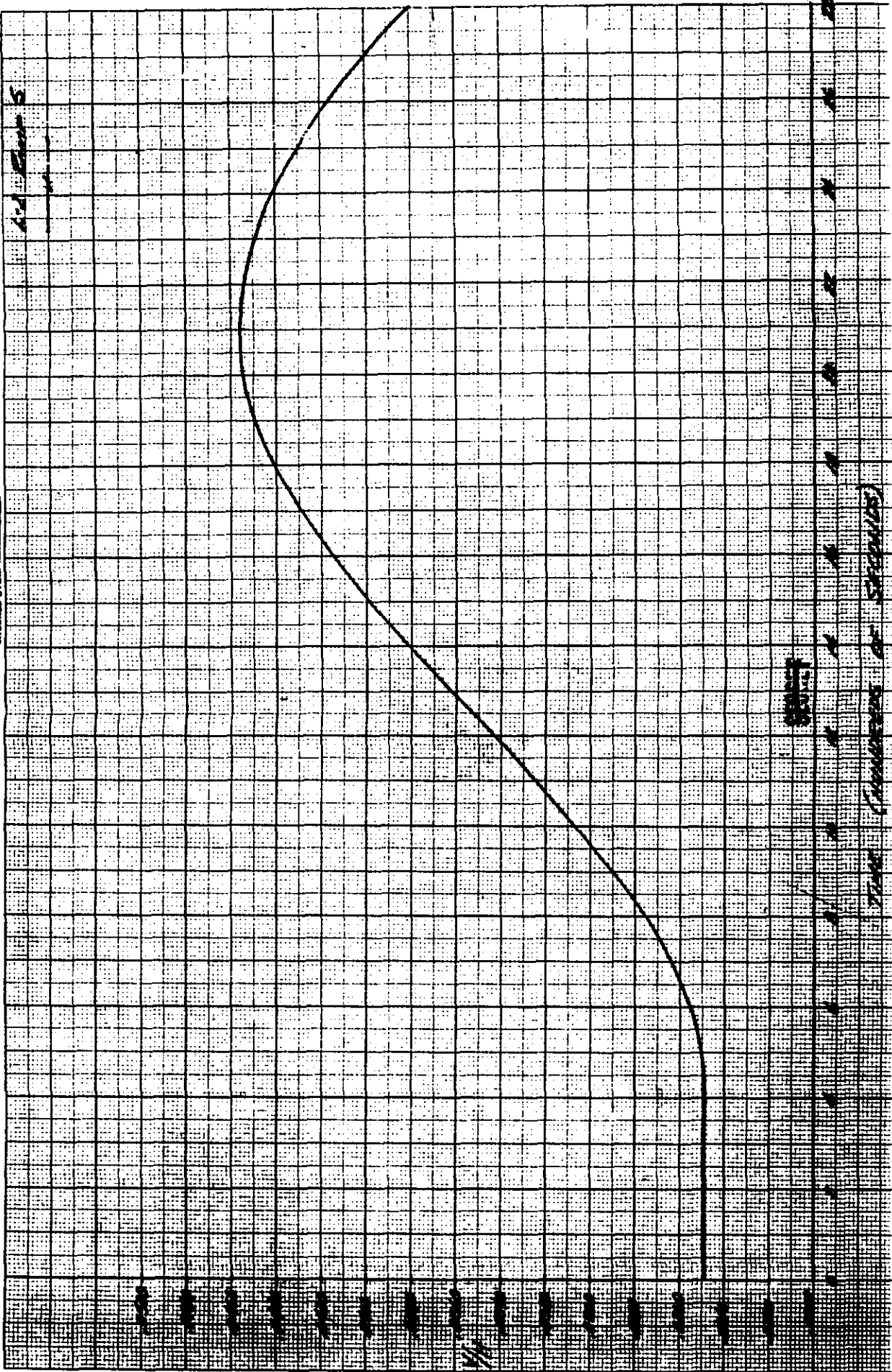

TIME (MINUTES OF SPEEDS)

1.2
1.2
1.2

PREPARED BY
DATE
CHECKED BY

STRONG
SQUIL

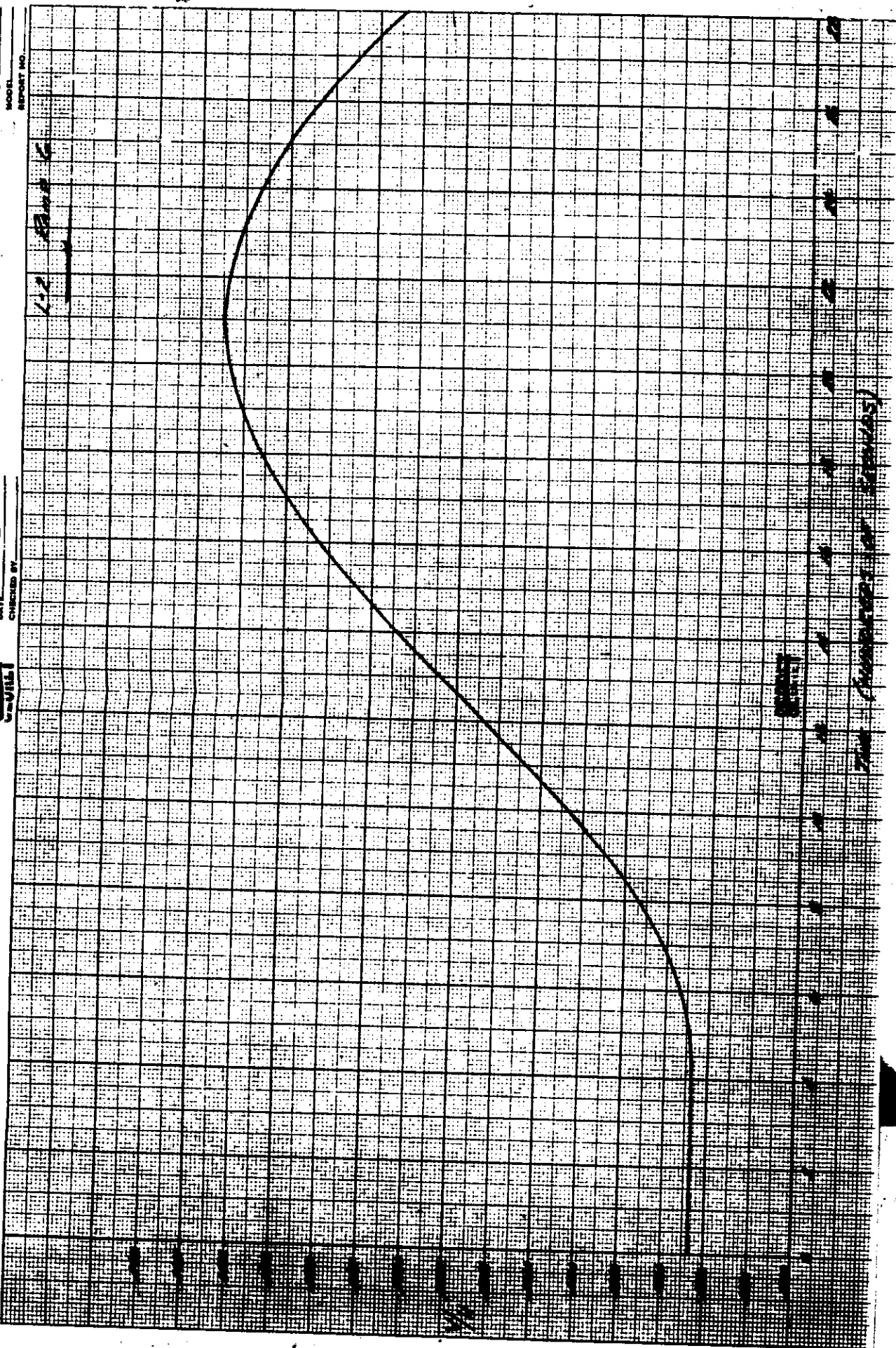

Time (minutes) for 250000

PREPARED BY
DATE
CHECKED BY

SECRET

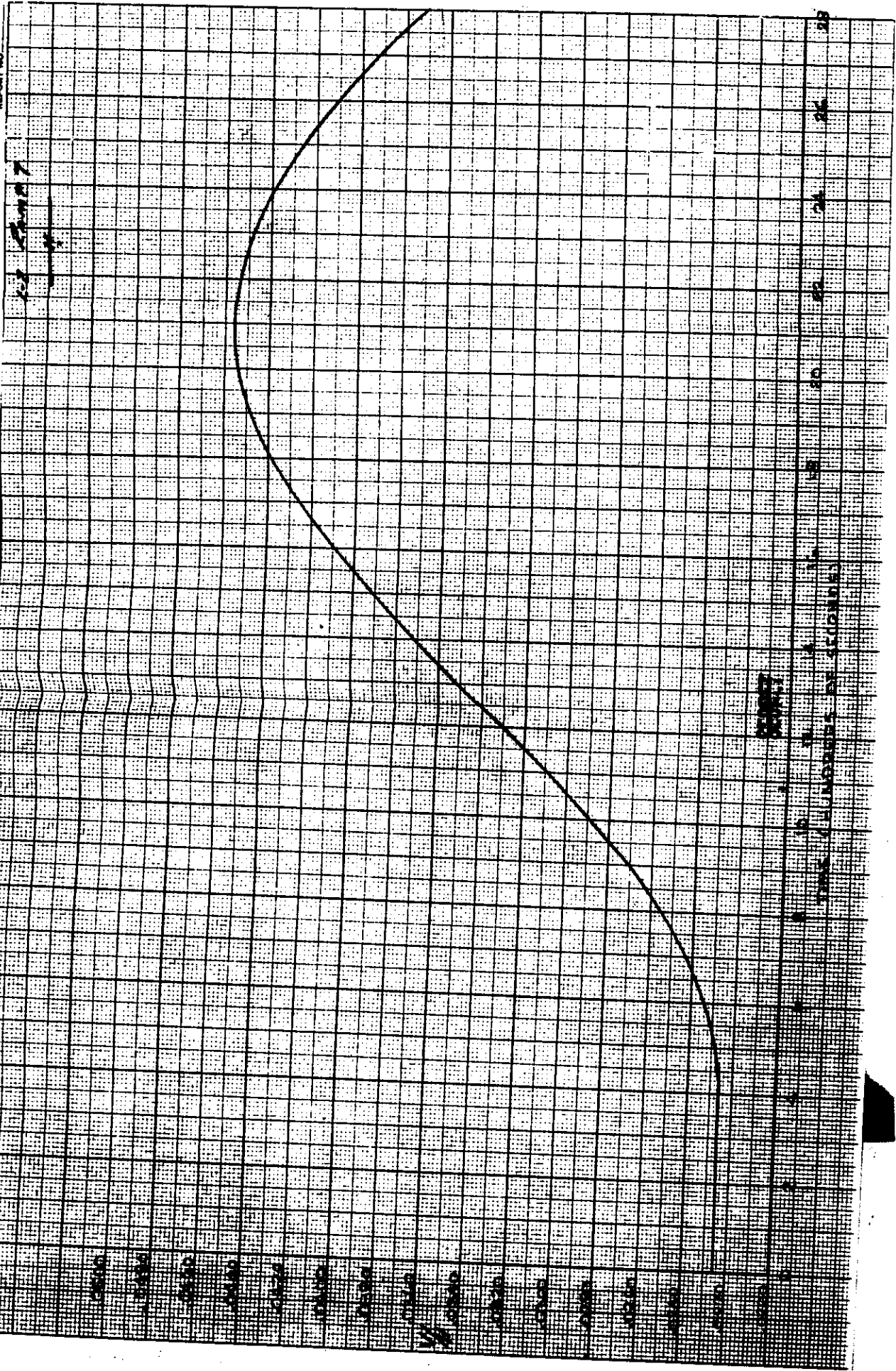

SECRET

TIME (HOURS BY CLOCK)

REPORT NO.

42-1010

DATE
CONDUCTED BY

STATION

10
9
8
7
6
5
4
3
2
1

TIME (MINUTES OF OBSERVATION)

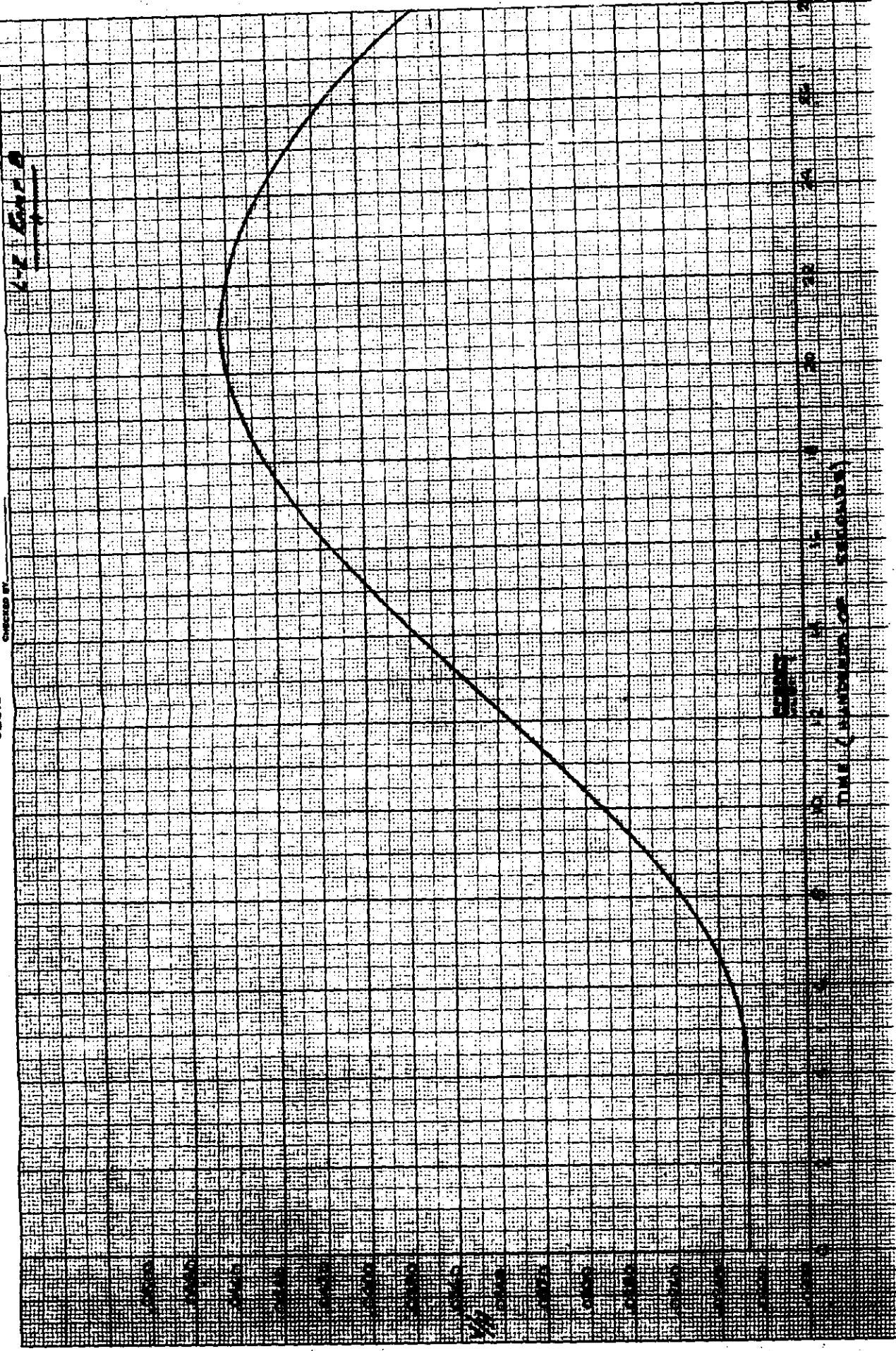

PREPARED BY
DATE
CHECKED BY

SECRET

MODEL
REPORT NO.

1-2-59

20 21 22 23 24 25 26 27 28 29 30 31 32 33 34 35 36 37 38 39 40 41 42 43 44 45 46 47 48 49 50 51 52 53 54 55 56 57 58 59 60 61 62 63 64 65 66 67 68 69 70 71 72 73 74 75 76 77 78 79 80 81 82 83 84 85 86 87 88 89 90 91 92 93 94 95 96 97 98 99 100

TIME (MINUTES) OF SECRETARY

SECRET

1 2 3 4 5 6 7 8 9 10 11 12 13 14 15 16 17 18 19 20 21 22 23 24 25 26 27 28 29 30 31 32 33 34 35 36 37 38 39 40 41 42 43 44 45 46 47 48 49 50 51 52 53 54 55 56 57 58 59 60 61 62 63 64 65 66 67 68 69 70 71 72 73 74 75 76 77 78 79 80 81 82 83 84 85 86 87 88 89 90 91 92 93 94 95 96 97 98 99 100

MODEL REPORT NO. PREPARED BY DATE CHECKED BY

1-1-10

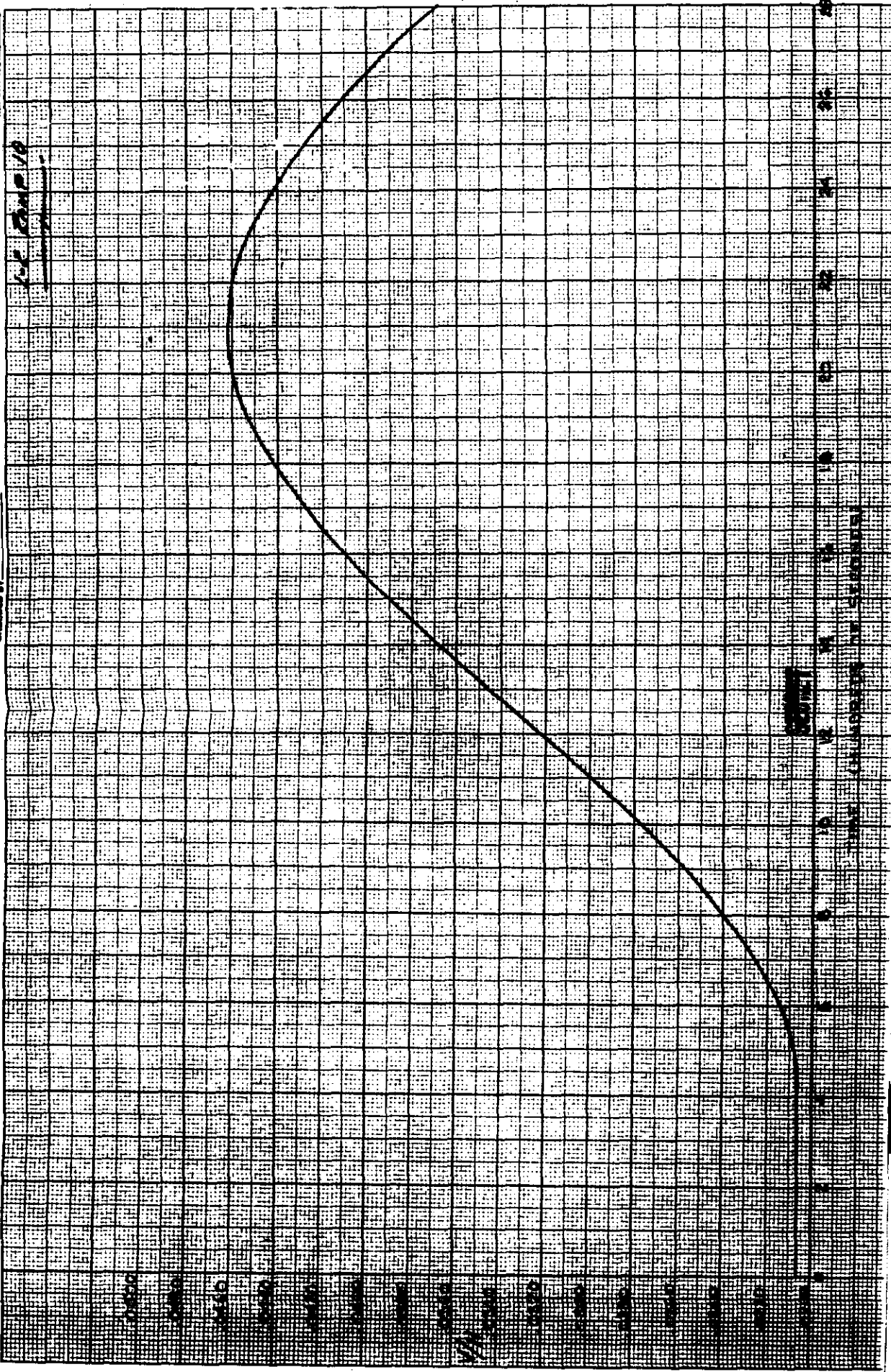

1-1-10

PREPARED BY [REDACTED]
DATE 3-9-63
CHECKED BY [REDACTED] 165 L-2

SECURITY
CLASSIFICATION

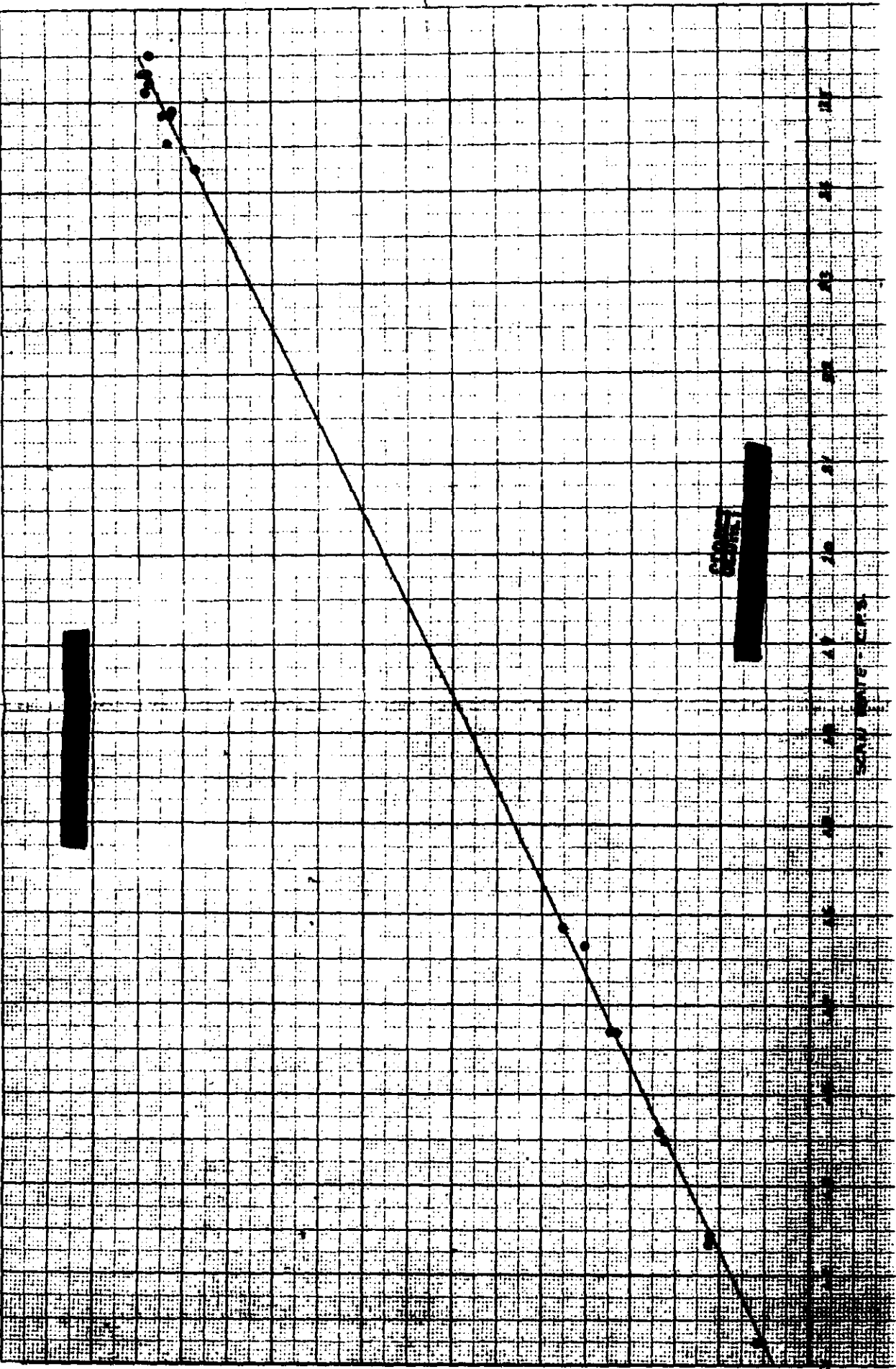

SECRET

NAVY WAREHOUSE

PREPARED BY [REDACTED]
DATE 5-9-63
CHECKED BY [REDACTED]

STAIN
SCALING

